

## 1641 Electric SmartDriver

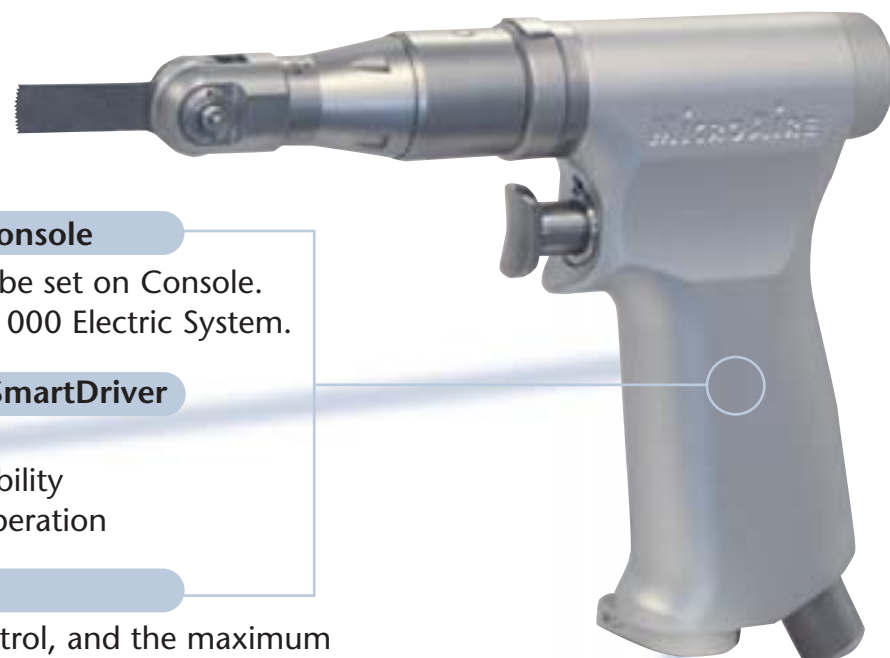

### Powered by the 1025 Console

Maximum speed can be set on Console.  
Complements Series 1000 Electric System.

### Advantages of Electric SmartDriver

Dedicated Power  
Convenience of Portability  
Quiet and Smooth Operation

### Variable-Speed Trigger

Allows for precise control, and the maximum speed can be set on the 1025 Console.

# Control

## 6640 Pneumatic SmartDriver



### Advantages of Pneumatic SmartDriver

Time-proven reliability of air power.  
Can be adapted to many existing air systems (see back cover for details).  
Perfect addition to your Series 1000 Pneumatic System.

### Variable-Speed Trigger

Allows for precise control.

### One-Hand Operation

Forward / Reverse control right on instrument base.

## SmartDriver Ordering Information

### Systems

#### Battery SmartDriver XT

6642B Battery SmartDriver XT Handpiece  
6640-710 NiMH SmartDriver Battery  
7500-700 MicroAire NiMH Battery Charger

#### Electric SmartDriver

1641 Electric SmartDriver Handpiece  
1006-1000 Electric Handpiece Cable  
1025 Universal Electric Console

#### Pneumatic SmartDriver

6640-100 Pneumatic SmartDriver Handpiece (with MicroAire Hose Connector)  
other hose connectors available specify as follows:

6640-200 Hall® Connector  
6640-300 3M® "Mini" Connector  
6640-350 3M® "Maxi" Connector  
6640-400 Stryker® Connector  
6640-600 Synthes® Connector

9000-000 10' (3m) Air Hose

9000-020 20' (6m) Air Hose



### Couplers

#### Drilling/Pinning Couplers

6645 Wire Driver Coupler  
accepts wires .028" to .062" - (0.7mm to 1.6mm)  
6650 Pin Driver Coupler  
accepts pins .078" to .125" - (2.0mm to 3.2mm)  
6660 Trinkle Driver  
6690 Synthes Driver  
6680 5/32" Jacobs Driver

#### Reaming Couplers

6685 1/4" Jacobs High-Torque Reaming Coupler  
6665 Hudson High-Torque Reaming Coupler  
6687 Zimmer High-Torque Reaming Coupler

#### Sawing

6670 Sagittal Saw Coupler  
6672 Keyless Sagittal Saw Coupler  
6673 Heavy Duty Sagittal Saw Coupler  
6400 Reciprocating Saw Coupler

#### Pulse Lavage

6640-474 Pulse Lavage Coupler

### Accessories

6651-100B SmartDriver Sterilization Case

Designed to hold any SmartDriver handpiece, couplers, and power cable or hose.

7025 Direct Power Console (DPC)

7007-000 DPC to Handpiece Cable

Designed to connect the 6640B Battery SmartDriver Handpiece to the 7025 Direct Power Console.

Please refer to your MicroAire catalog or [www.microaire.com](http://www.microaire.com) for more accessories for your SmartDriver system, including disposable surgical accessories, pneumatic accessories, and brushes.

**MicroAire**<sup>®</sup>  
SURGICAL INSTRUMENTS

1641 Edlich Drive Charlottesville, VA 22911 U.S.A.  
TOLL FREE (800) 722-0822 (434) 975-8000  
FAX (800) 648-4309 (434) 975-4131

Visit us online at:  
[www.microaire.com](http://www.microaire.com)



A COLSON ASSOCIATE

©2004, MicroAire Surgical Instruments LLC. Lit SMARTDRIVER Rev. D. All rights reserved. Printed in USA 504

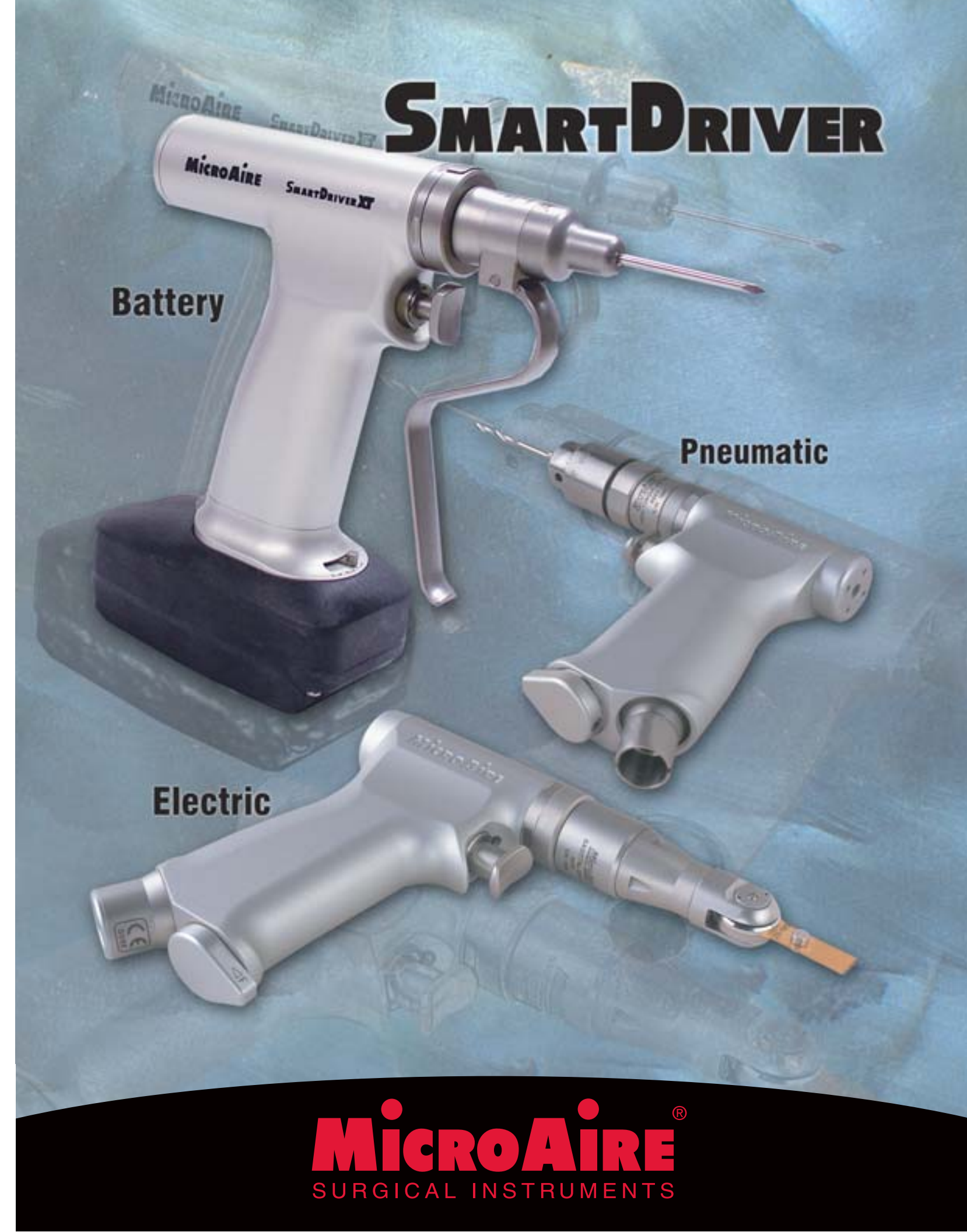

**MicroAire**<sup>®</sup>  
SURGICAL INSTRUMENTS

# 6642B Battery SmartDriver XT

Powerful



### Cordless Freedom

No cables or hoses in the way.

### Variable-Speed Trigger

Allows for precise control.

### One-Hand Operation

Forward/Reverse/Oscillate control right on instrument base.

### Oscillating Drill Function

Designed for percutaneous drilling and fixation.

### Advanced NiMH Battery Technology

- Quick Charging
- Environmentally Friendly
- More Power
- Autoclavable

The Battery, Electric, and Pneumatic SmartDrivers accept the same wide selection of couplers, making all SmartDrivers an excellent choice for:

- ✓ ACL Surgery
- ✓ IM Nailing
- ✓ Trauma
- ✓ Lavage
- ✓ Osteotomies
- ✓ Internal Fixation
- ✓ External Fixation
- ✓ Ilizarov Fixation
- ✓ Drilling
- ✓ Reaming

Versatile

## Drilling Couplers



6660 Trinkle Driver



6690 Synthes® Driver



6680 5/32" Jacobs Driver

## Saw Couplers



6670 Sagittal Saw



6672 Keyless Sagittal Saw



6673 Heavy Duty Sagittal Saw



6400 Reciprocating Saw

## Reaming Couplers



6685 1/4" Jacobs High-Torque Reaming Coupler

Heavy Duty  
High Torque



6665 Hudson® High-Torque Reaming Coupler

Heavy Duty  
High Torque



6687 Zimmer® High-Torque Reaming Coupler

Heavy Duty  
High Torque

## Blade Choices by Couplers

Please refer to the MicroAire Accessory Chart (LIT-2001) for a full listing of available disposable blades.

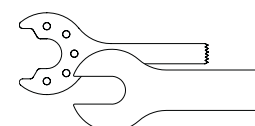

Accepts MicroAire ZS-0XX and ZS-3XX Sagittal Blades.

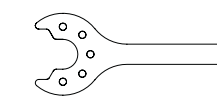

Accepts MicroAire ZS-3XX Sagittal Blades.

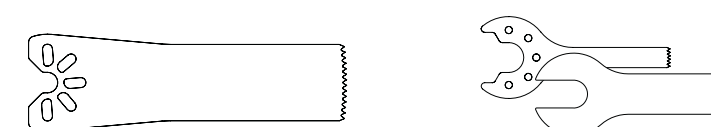

Accepts MicroAire ZO-7XXX (must not be longer than 71mm). Also accepts MicroAire ZS-0XX and ZS-3XX Sagittal Blades.

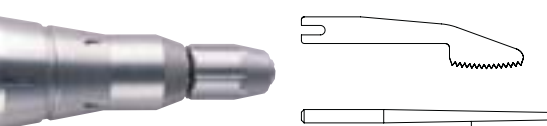

Accepts MicroAire 1400 Series Reciprocating Blades and certain ZR Series Reciprocating Blades.

## Wire/Pin Couplers



6645 Automatic Wire Driver for wires from .028" to .062" (0.7mm to 1.6mm)



6650 Automatic Pin Driver for pins from .078" to .125" (1.7mm to 3.2mm)

## Pulse Lavage Coupler



6640-474 Pulse Lavage Coupler

Part of the MicroAire Pulse Lavage system, used for debriding bone surfaces and cleaning trauma and other soft tissue wounds. MicroAire offers a wide range of tubing sets for specific surgical applications, with extra nozzles and splash shields available.

## MicroAire Power Choices



7500-700 MicroAire Battery Charger

The MicroAire 7500-700 Battery Charger will charge up to four of any of the MicroAire NiMH batteries at one time. Both SmartDriver and Large Power batteries can be charged at the same time.

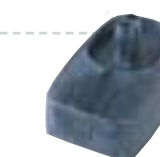

6640-710 SmartDriver Battery

14.4v Nickel-Metal Hydride Autoclavable - Environmentally Friendly

**NiMH**  
NICKEL-METAL HYDRIDE



1025 Universal Electric Console

The power source for the 1641 Electric SmartDriver, the 1025 Console also powers the MicroAire Series 1000 Electric Instruments, along with the Power Assisted Lipoplasty (PAL) Device. Precise speeds can be achieved by simply turning the knob on the front of the console.



7025 Direct Power Console

The 7025 Direct Power Console allows conversion of the 6642B Battery SmartDriver XT to a corded electric system, providing direct power to the handpiece at all times.

The 7007-000 Adapter (not shown) locks into the battery receptacle on the handpiece, and the connecting cable connects to the 7025 Console.



Air Hoses and Accessories

For the 6640 Pneumatic SmartDriver, MicroAire offers air hoses in multiple lengths and connector styles to work with existing air systems. MicroAire also offers pneumatic regulators, manifolds and adapters, shown in the Hoses & Accessories section in your MicroAire catalog.

SmartDriver